

**Concealed three-way diverter - Chrome**











CL.1

36 210 740

- rotary diverter
- without rosette
- handle Ø 60mm



Fits: CL.1, META, CYO

	Chrome	36 210 740-00
	Brushed Platinum	36 210 740-06
	Light Gold	36 210 740-26
	Brushed Light Gold	36 210 740-27
	Brushed Durabronze (23kt Gold)	36 210 740-28
	Matte Black	36 210 740-33
	Brushed Bronze	36 210 740-42
	Brushed Champagne (22kt Gold)	36 210 740-46
	Champagne (22kt Gold)	36 210 740-47
	Brushed Dark Platinum	36 210 740-99

**Required miscellaneous**



- Concealed three-way diverter - 35 203 970 90**
- max. recess depth 160 mm
  - min. recess depth 85 mm

36 210 740

mm [inches]

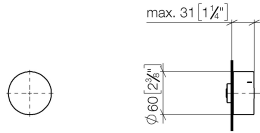

Flow rate chart



Certificates

LGA\_38380.

WRAS\_2307045.

36 210 740

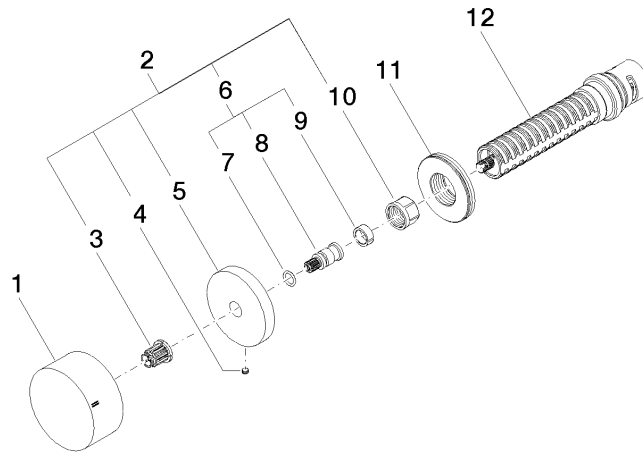

### Spare parts list

No.	Item Number	Name	Quantity used	Delivery time
1	09 20 74 045-00	handle	1	60
2	04 27 74 004 00-00	rosette	1	10
3	90 12 12 002 00 90	fixing cap	1	2
4	09 31 11 055 90	pin	1	2
5	09 27 74 004-00	rosette	1	10
6	04 29 06 020 00-00	spindle	1	10
7	90 14 10 060 00 90	seal	1	2
8	09 29 06 020-00	spindle	1	10
9	90 14 15 020 03 90	ring	1	2
10	90 23 30 023 00 90	nut	1	2
11	09 30 01 107 90	sleeve	1	2
12	90 90 03 303 10 90	diverter	1	2